

# Data Sheet

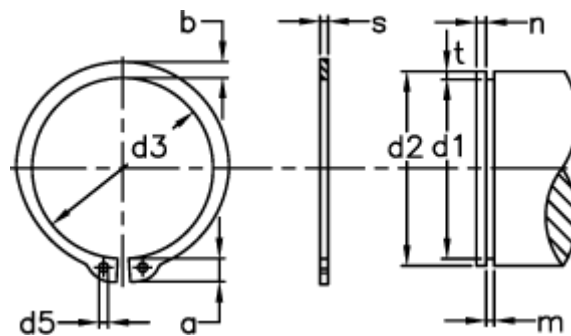

Article number: 0109039  
 Description: Retaining ring AS 22x1.75  
 Spring steel  
 Note: Fitted with ZGA pliers

## Measures



a max	= 6.0	Description	= AS 22	s	= 1.75
AN mm <sup>2</sup>	= 33.8	FN kN	= 5.60	t	= 0.50
B	= 2.12	FRg kN	= 8.1	tol	= -0.21
b	= 3.1	FR kN	= 36.0	tol	= -0.06
d1	= 21.0	g	= 1.5	tol	= +0,21 -0,42
d2	= 22	m min	= 1.85	Tong	= ZGA-2
d3	= 20.5	n abl x 1000	= 29	Weight kg/1000	= 2.30
d5 min	= 2.0	Nominal drive	= 1.5		